

Electronic Lock

- GB Quick user guide
- FR Mini-guide de l'utilisateur
- DE Kurzanleitung
- NL Beknopte handleiding
- IT Guida veloce
- ES Guía rápida de usuario
- PT Guia rápido do Utilizador
- PL Krótki podręcznik użytkownika
- RU Краткое руководство пользователя
- SE Snabb bruksanvisning
- NO Hurtigguide
- DK Hurtig brugervejledning
- FI Pikaopas
- ID Panduan cepat untuk pengguna
- CN 便捷用户指南
دليل الاسترخ دام الـسرري ع

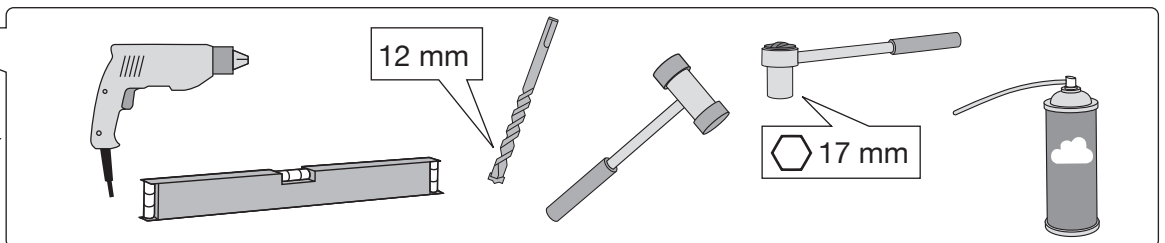
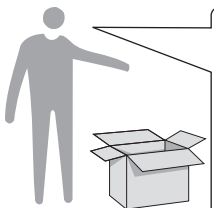
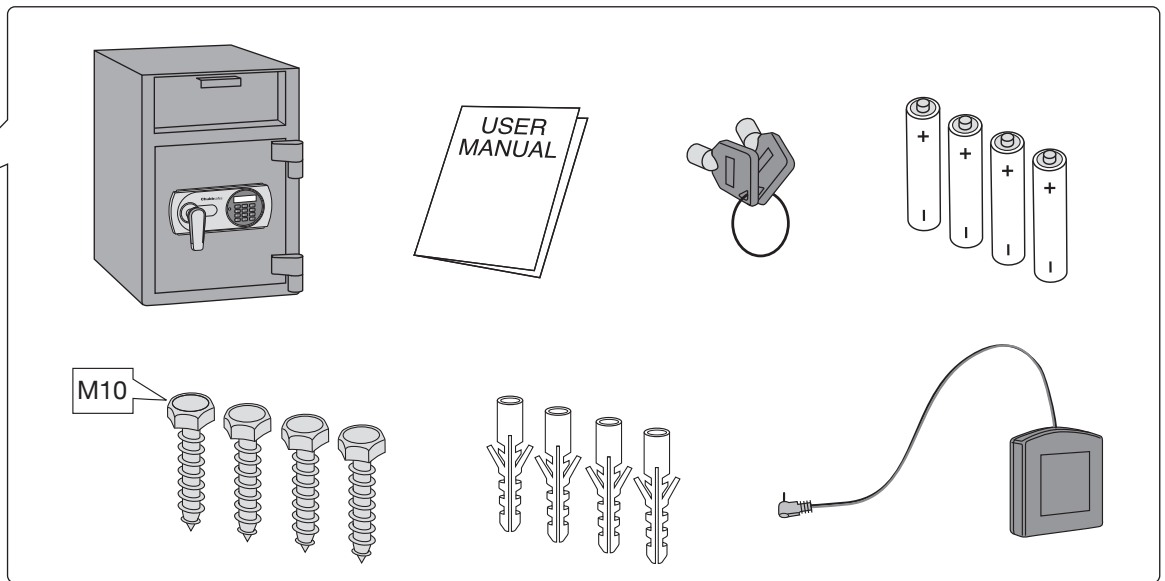
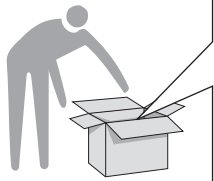
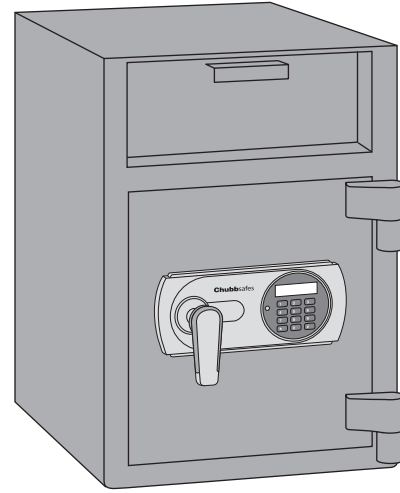

Chubbsafes
Trusted the world over.

<http://www.chubb safes.com>

'Chubb' is owned by Chubb plc and is a registered trademark used under license

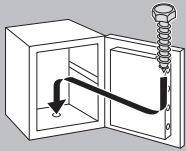

GB The safe must be anchored when in use.
 FR Le coffre doit être ancré.
 DE Wenn der Safe verwendet wird, muss er verankert sein.
 NL De kluis moet tijdens gebruik verankerd zijn.
 IT La cassaforte deve essere fissata durante l'uso.
 ES La caja debe anclarse al usarla.
 PT O cofre tem de encontrar-se fixado quando em utilização.
 PL Sejf jeżeli jest używany musi być zamocowany.

RU Сейф должен быть укреплен перед использованием.
 SE Kassaskåpet måste vara förankrat när det används.
 NO Safen må være forankret når den er i bruk.
 DK Pengeskabet skal være fastgjort, når det er i brug.
 FI Kassakaapin on oltava käytön aikana kiinnitettyinä.
 ID Pengaman harus ditanamkan pada saat digunakan.
 CN 使用中的保险柜必须固定在某个位置。
 يجب أن تكون الخزنة ثابتة أثناء الاستخدام.

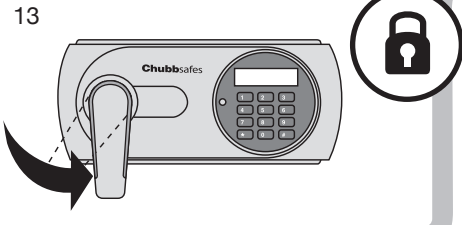
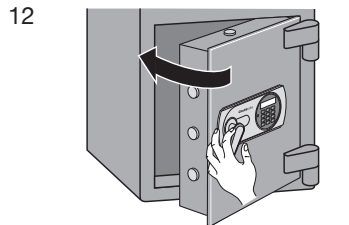
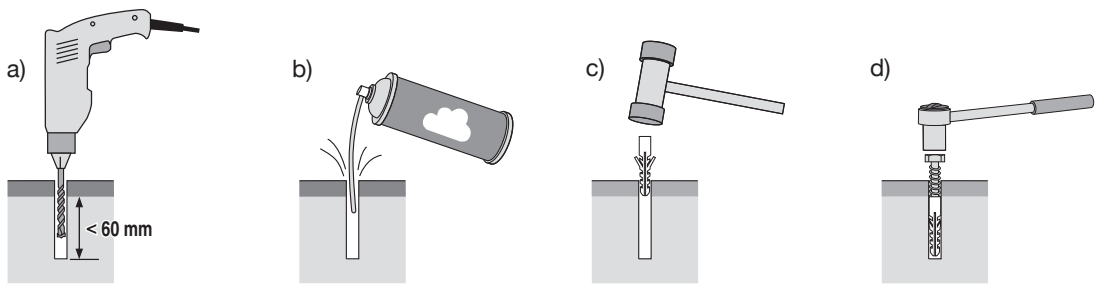
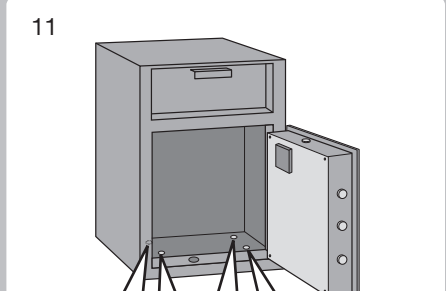
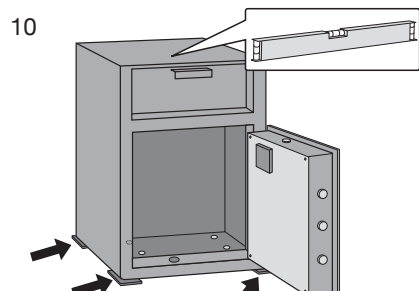
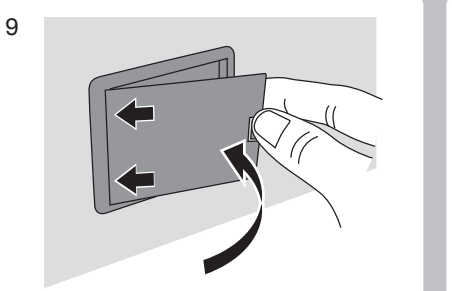
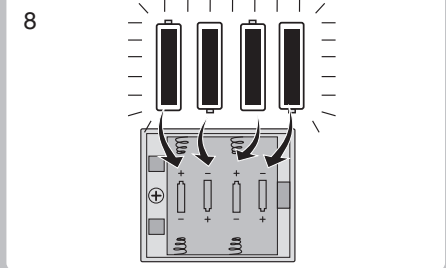
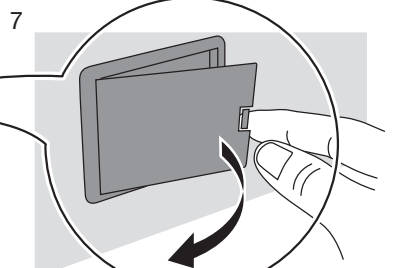
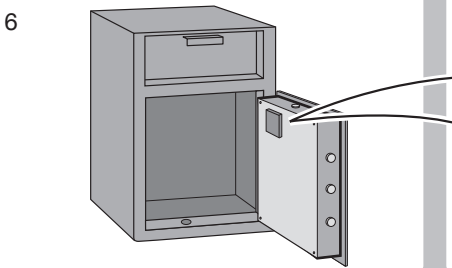
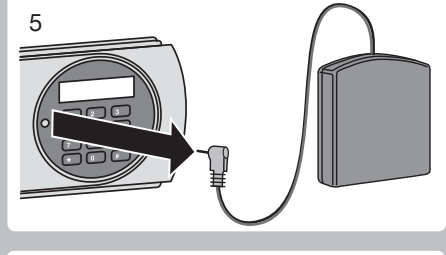
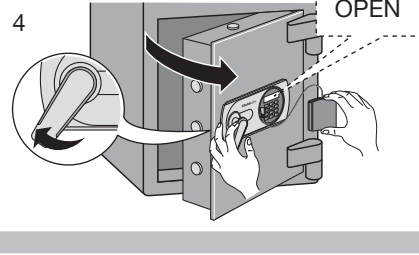
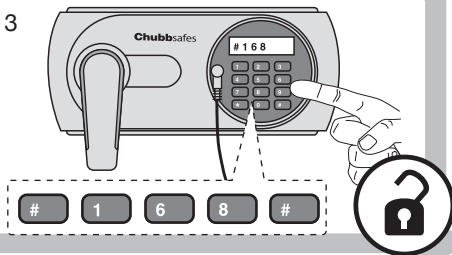
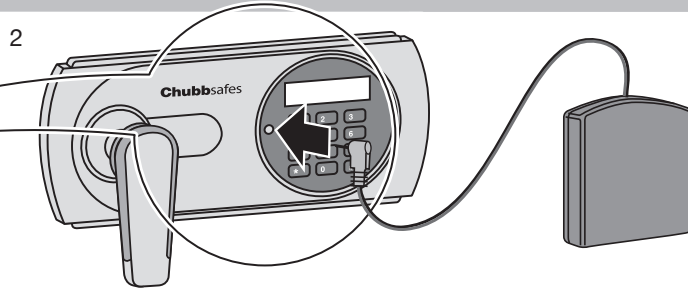
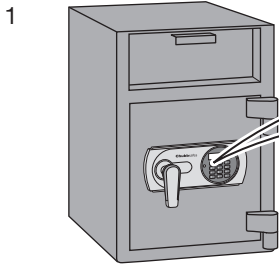

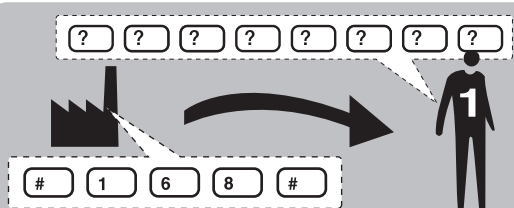

GB Setting new user code.
 FR Définition d'un nouveau code utilisateur.
 DE Neuen Benutzercode festlegen.
 NL Nieuwe gebruikerscode instellen.
 IT Impostazione nuovo codice utente.
 ES Configuración del nuevo código de usuario.
 PT Definir o novo código do utilizador.
 PL Ustawienie nowego kodu użytkownika.

RU Установка кода нового пользователя.
 SE Ställa in ny användarkod.
 NO Stille inn en ny brukerkode.
 DK Indstilling af ny brugerkode.
 FI Uuden käyttäjäkoodin määrittäminen.
 ID Pengaturan kode pengguna baru.
 CN 设置新的用户密码。
 إعداد كود جديد للمستخدم.

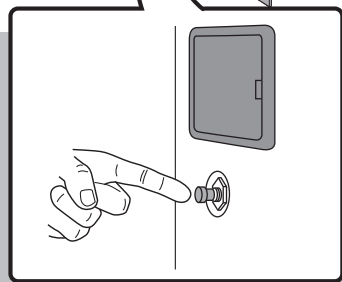
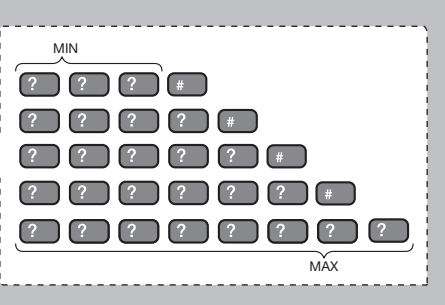
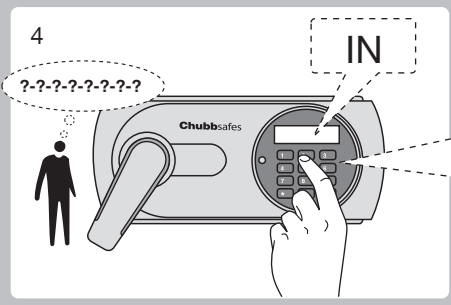
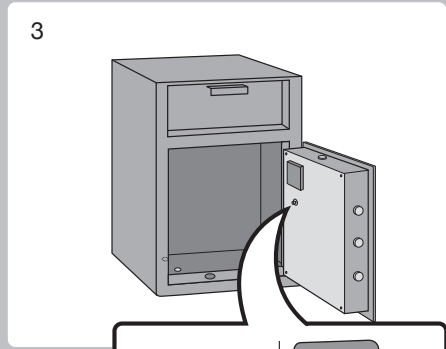
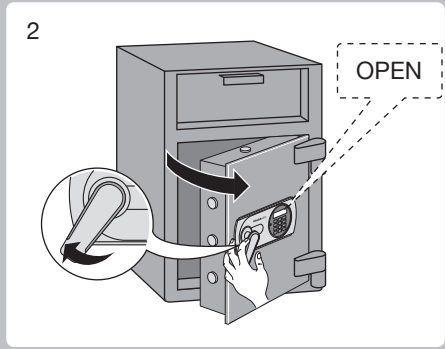
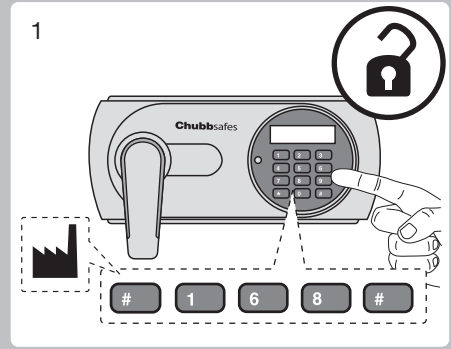

✓

MIN MAX

OPEN

GB To check that your PIN code has been accepted operate the lock three times without closing the door. If unsure repeat the steps above.
 FR Pour vérifier que votre code PIN a été accepté, faites fonctionner la serrure trois fois sans fermer la porte. En cas de doute, répétez les étapes précédentes.
 DE Um sicherzustellen, dass Ihr PIN-Code akzeptiert wurde, schließen Sie das Schloss dreimal hintereinander ab und auf, ohne die Tür zu schließen. Wenn dies nicht reibungslos funktioniert, wiederholen Sie die o. g. Schritte.
 NL Controleer of uw pincode is aanvaard door het slot drie keer te bedienen zonder de deur te sluiten. Doorloop bij twijfel bovenstaande stappen opnieuw.
 IT Per controllare che il codice PIN sia stato accettato, azionare la serratura tre volte senza chiudere la porta. In caso di dubbi, ripetere le operazioni precedenti.
 ES Para comprobar que su código PIN ha sido aceptado, active la cerradura tres veces sin cerrar la puerta. En caso de duda, repita los pasos anteriores.
 PT Para se certificar de que o seu código PIN foi aceite, acione a fechadura três vezes sem fechar a porta. Caso não tenha a certeza, repita os passos acima.
 PL Aby sprawdzić czy kod PIN został zaakceptowany, należy uruchomić zamek trzy razy bez zamykania drzwi sejfów. W przypadku braku pewności należy powtórzyć powyższe kroki.
 RU Для того, чтобы убедиться, что Ваш PIN код был принят проверти замок три раза не закрывая дверь. Если вы все еще неуверенны, повторите вышеуказанные шаги.
 SE För att kontrollera att PIN-koden är godkänd ska du använda låset tre gånger utan att stänga dörren. Upprepa ovanstående steg om du är osäker.
 NO Kontroller at PIN-koden er registrert ved å bruke låsen tre ganger uten å lukke døren. Hvis du er usikker, gjentar du trinnene ovenfor.
 DK Afprøv pinkoden på låsen tre gange uden at lukke døren for at kontrollere, om pinkoden er accepteret. Gentag ovenstående trin, hvis du ikke er sikker.
 FI Tarkista, että PIN-koodisi on hyväksytty, käyttämällä lukkoa kolme kertaa ovea sulkematta. Jos olet epävarma, toista edellä kuvatut vaiheet.
 ID Untuk memeriksa kode PIN Anda telah diterima, operasikan kunci tiga kali tanpa menutup pintu. Apabila kurang yakin, ulangi langkah-langkah tersebut di atas.
 CN 要检查PIN码是否设置成功,请在开门情况下,开关门3次;如果不确定,请重复操作以上步骤。
 للتحقق من قبول كود PIN الخاص بك، قم بتشغيل القفل ثلاث مرات دون إغلاق الباب. في حالة عدم التأكد، تكرر الخطوات السابقة.

Error!

3 x Error = 3 min

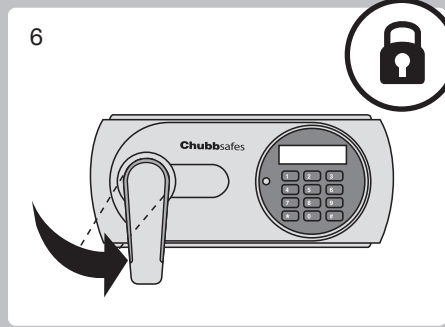

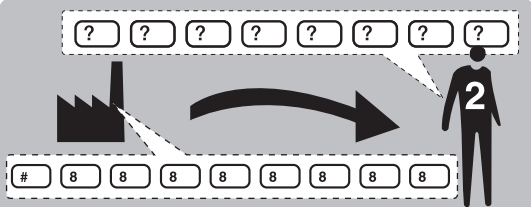

GB To set a 2nd PIN code.
 FR Pour définir un second code PIN.
 DE Einrichten eines zweiten PIN-Codes.
 NL Een tweede pincode instellen.
 IT Impostazione di un secondo codice PIN.
 ES Para configurar un segundo código PIN.
 PT Para configurar um 2.º código PIN.
 PL Aby ustawić drugi kod PIN.

RU Установка 2-ого PIN кода.
 SE Ställa in en andra PIN-kod.
 NO Definere en sekundær PIN-kode.
 DK Indstilling af pinkode nummer 2.
 FI Toisen PIN-koodin asettaminen.
 ID Mengatur kode PIN yang ke 2.
 CN 设置第 2 个 PIN 码。
 لضبط كود PIN آخر.

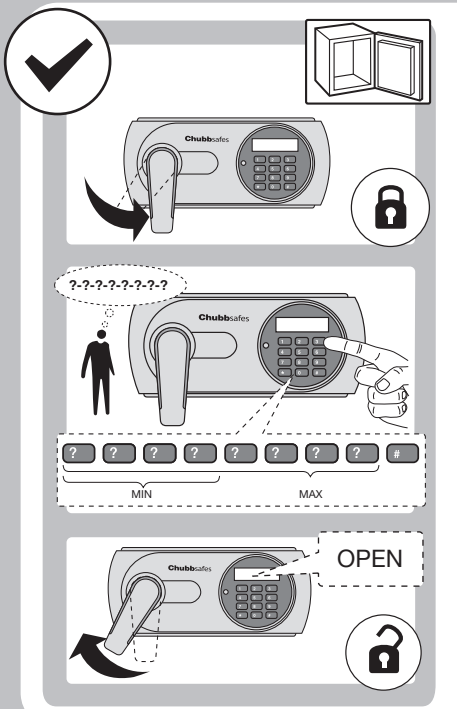
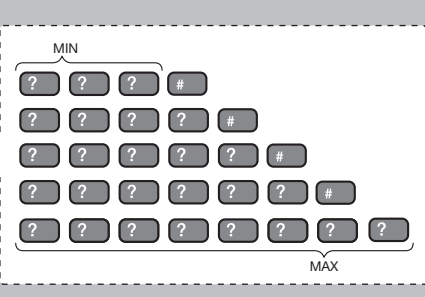
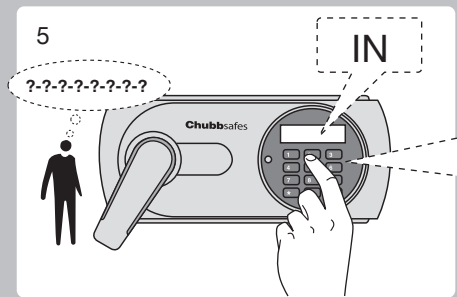
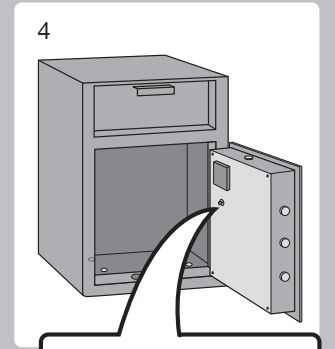
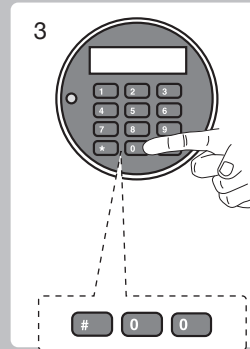
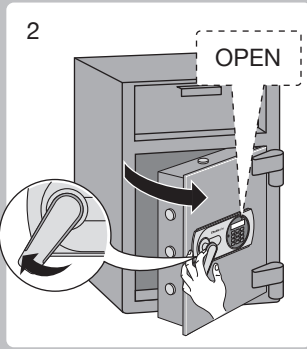
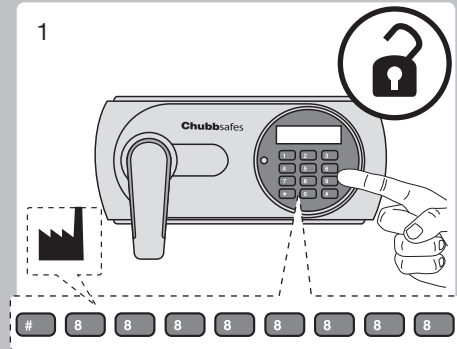

GB To check that your PIN code has been accepted operate the lock three times without closing the door. If unsure repeat the steps above.
 FR Pour vérifier que votre code PIN a été accepté, faites fonctionner la serrure trois fois sans fermer la porte. En cas de doute, répétez les étapes précédentes.
 DE Um sicherzustellen, dass Ihr PIN-Code akzeptiert wurde, schließen Sie das Schloss dreimal hintereinander ab und auf, ohne die Tür zu schließen. Wenn dies nicht reibungslos funktioniert, wiederholen Sie die o. g. Schritte.
 NL Controleer of uw pincode is aanvaard door het slot drie keer te bedienen zonder de deur te sluiten. Doorloop bij twijfel bovenstaande stappen opnieuw.
 IT Per controllare che il codice PIN sia stato accettato, azionare la serratura tre volte senza chiudere la porta. In caso di dubbi, ripetere le operazioni precedenti.
 ES Para comprobar que su código PIN ha sido aceptado, active la cerradura tres veces sin cerrar la puerta. En caso de duda, repita los pasos anteriores.
 PT Para se certificar de que o seu código PIN foi aceite, acione a fechadura três vezes sem fechar a porta. Caso não tenha a certeza, repita os passos acima.
 PL Aby sprawdzić czy kod PIN został zaakceptowany, należy uruchomić zamek trzy razy bez zamykania drzwi sejfów. W przypadku braku pewności należy powtórzyć powyższe kroki.
 RU Для того, чтобы убедиться, что Ваш PIN код был принят проверти замок три раза не закрывая дверь. Если вы все еще не уверены, повторите вышеуказанные шаги.
 SE För att kontrollera att PIN-koden är godkänd ska du använda låset tre gånger utan att stänga dörren. Upprepa ovanstående steg om du är osäker.
 NO Kontroller at PIN-koden er registrert ved å bruke låsen tre ganger uten å lukke døren. Hvis du er usikker, gjentar du trinnene ovenfor.
 DK Afprøv pinkoden på låsen tre gange uden at lukke døren for at kontrollere, om pinkoden er accepteret. Gentag ovenstående trin, hvis du ikke er sikker.
 FI Tarkista, että PIN-koodisi on hyväksytty, käyttämällä lukkoa kolme kertaa ovea sulkematta. Jos olet epävarma, toista edellä kuvatut vaiheet.
 ID Untuk memeriksa kode PIN Anda telah diterima, operasikan kunci tiga kali tanpa menutup pintu. Apabila kurang yakin, ulangi langkah-langkah tersebut di atas.
 CN 要检查PIN码是否设置成功,请在开门情况下,开关门3次;如果不确定,请重复操作以上步骤。
 للتأكد من قبول كود PIN الخاص بك، قم بتشغيل القفل ثلاث مرات دون إغلاق الباب، في حالة عدم التأكد، تكرر الخطوات السابقة.

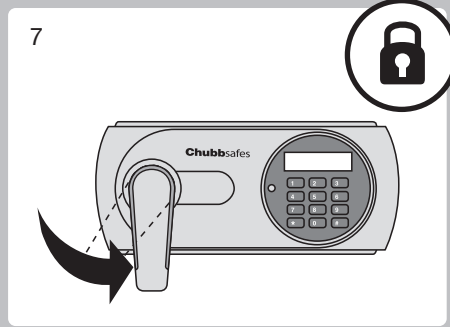
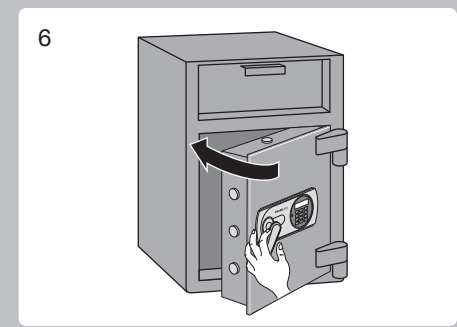

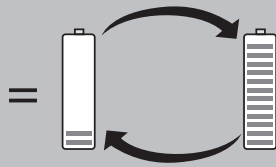

GB Low battery.
 FR Pile faible.
 DE Niedriger Batteriestand.
 NL Batterij bijna leeg.
 IT Batteria in esaurimento.
 ES Bateria agotada.
 PT Bateria fraca.
 PL Niski poziom baterii.

RU Аккумулятор разряжен.
 SE Låg batterinivå.
 NO Lavt batterinivå.
 DK Lav batteristand.
 FI Akun varaus vähissä.
 ID Baterai lemah.
 CN 电池电量低。
 شحن البطارية ضعيف.

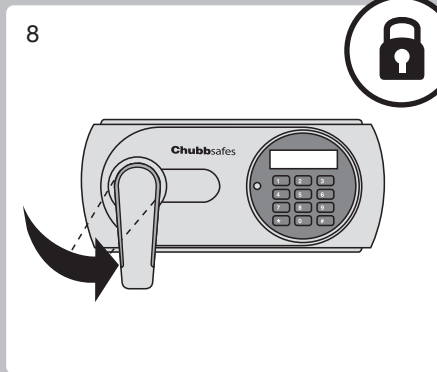
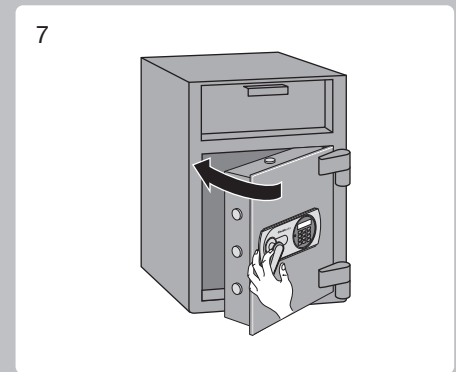
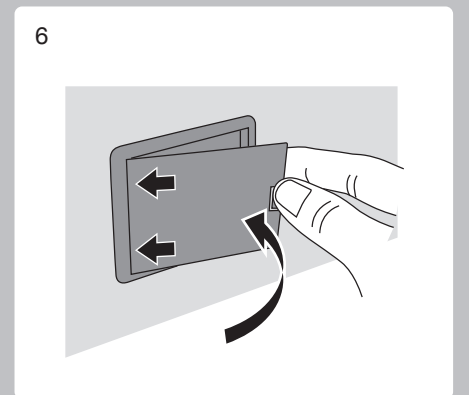
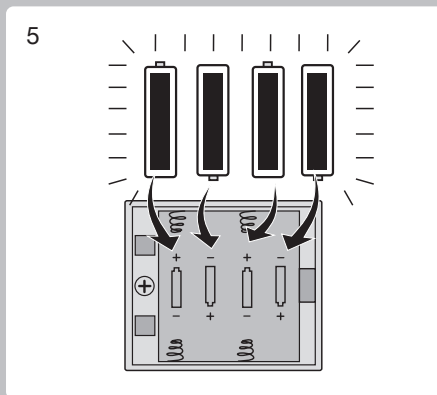
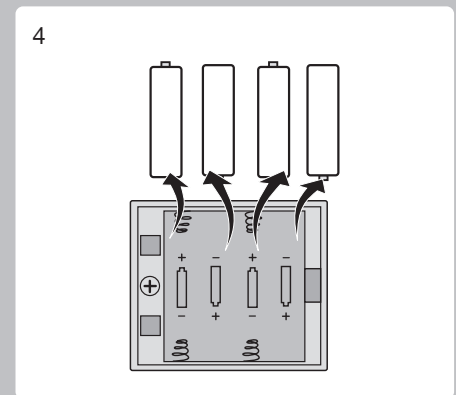
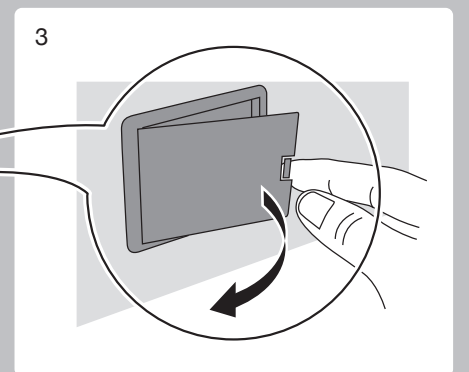
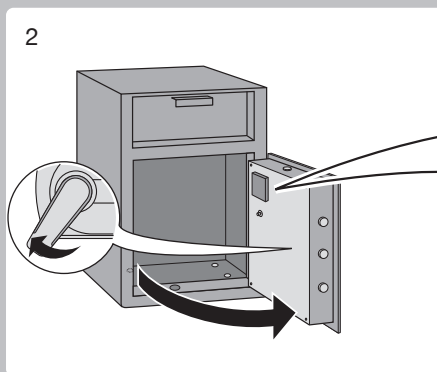
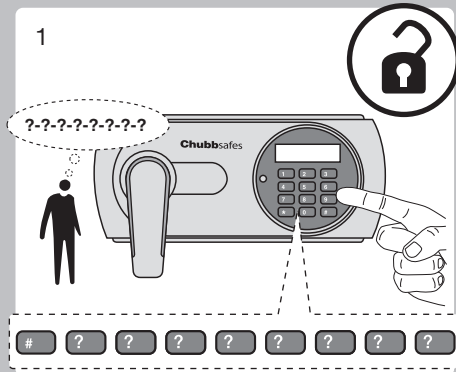

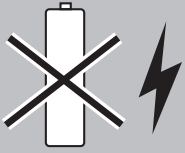

GB No battery power.
FR Pile déchargée.
DE Keine Batterieleistung.
NL Batterij leeg.
IT Batteria scarica.
ES Sin alimentación por batería.
PT Sem bateria.
PL Brak zasilania z baterii.

RU Нет питания аккумулятора.
SE Ingen batterikraft.
NO Batteriet er utladet.
DK Batteriet er tomt.
FI Akussa ei ole virtaa.
ID Tidak ada daya baterai.
CN 电池电量耗尽。
البطارية فارغة.

1

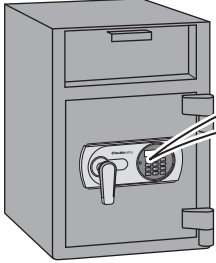

2

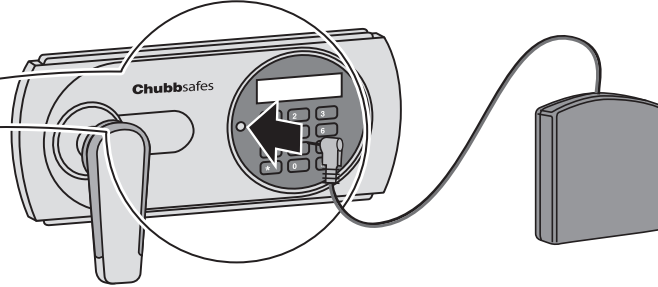

3

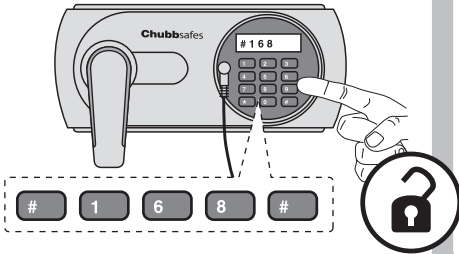

4

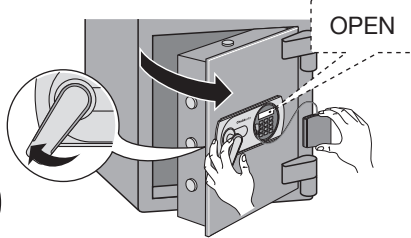

5

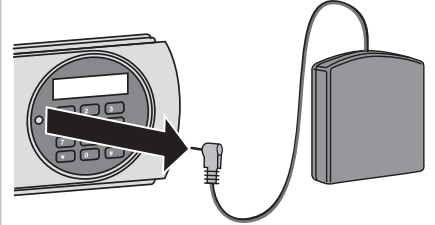

6

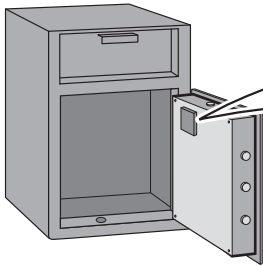

7

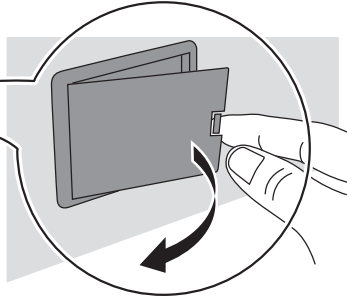

8

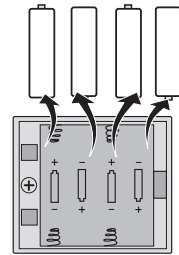

9

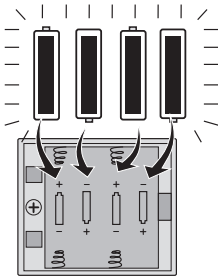

10

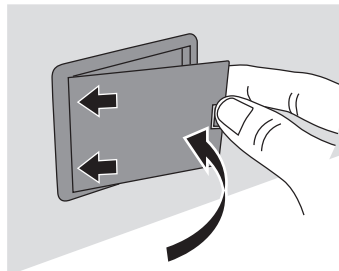

11

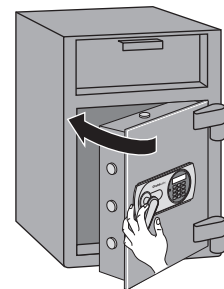

12

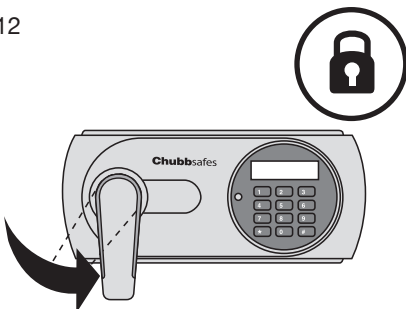

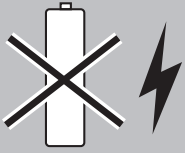

GB No battery power.
FR Pile déchargée.
DE Keine Batterieleistung.
NL Batterij leeg.
IT Batteria scarica.
ES Sin alimentación por batería.
PT Sem bateria.
PL Brak zasilania z baterii.

RU Нет питания аккумулятора.
SE Ingen batterikraft.
NO Batteriet er utladet.
DK Batteriet er tomt.
FI Akussa ei ole virttaa.
ID Tidak ada daya baterai.
CN 电池电量耗尽。
البطارية فارغة.

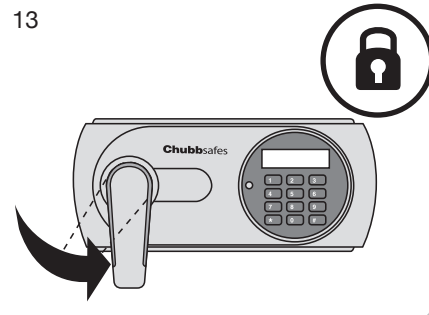
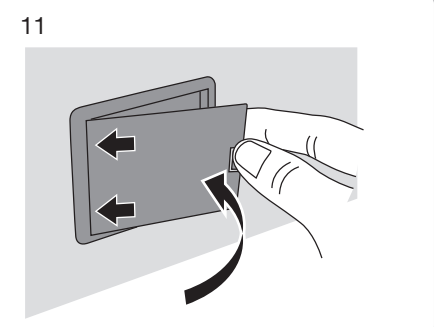
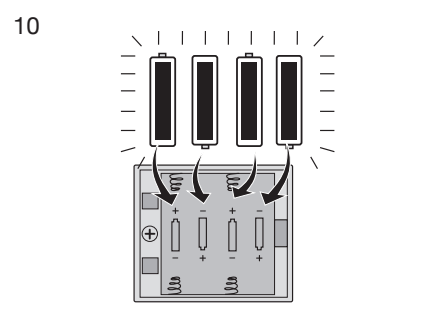
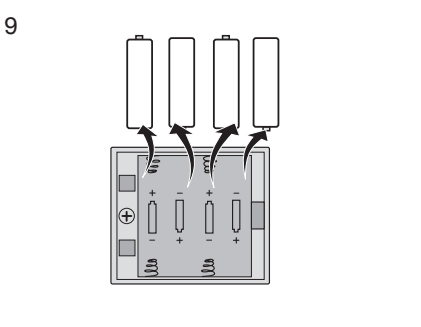
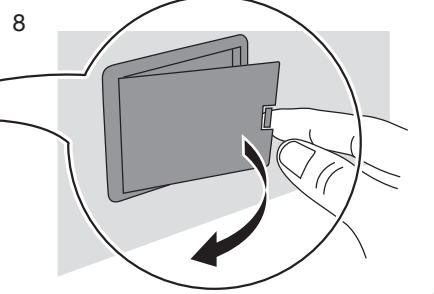
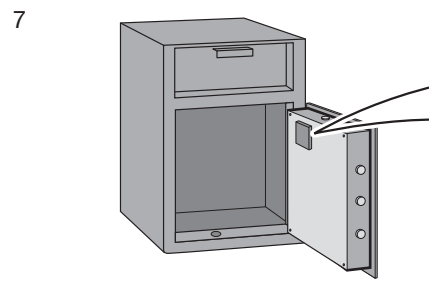
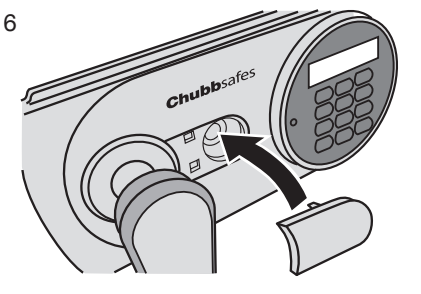
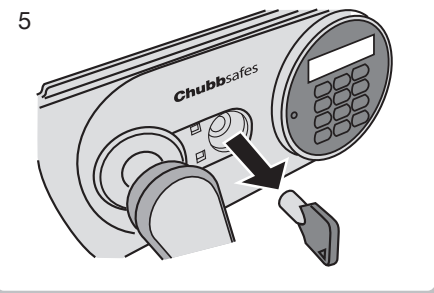
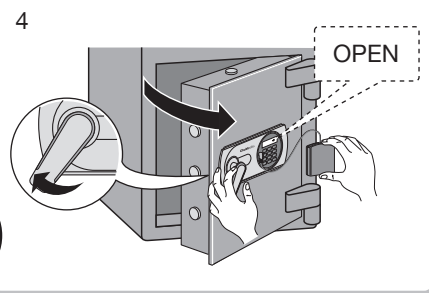
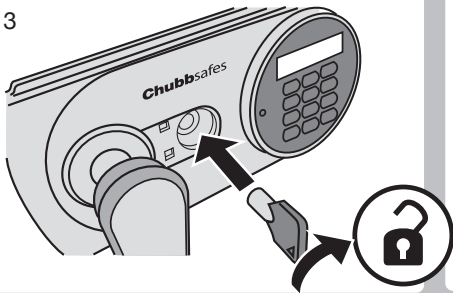
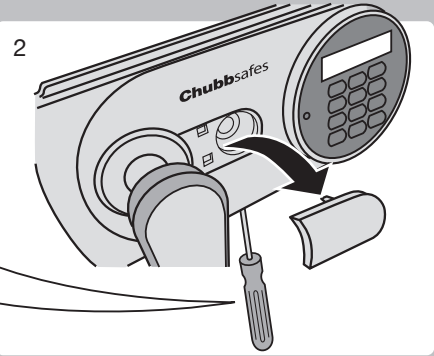
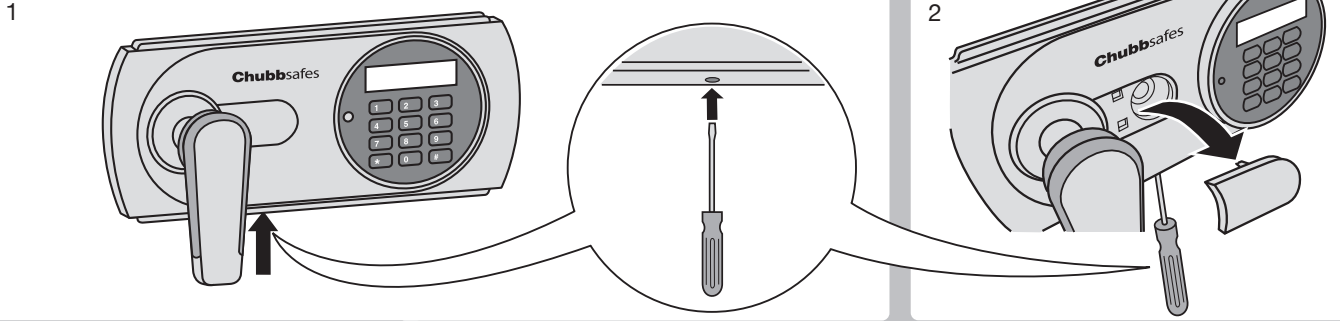

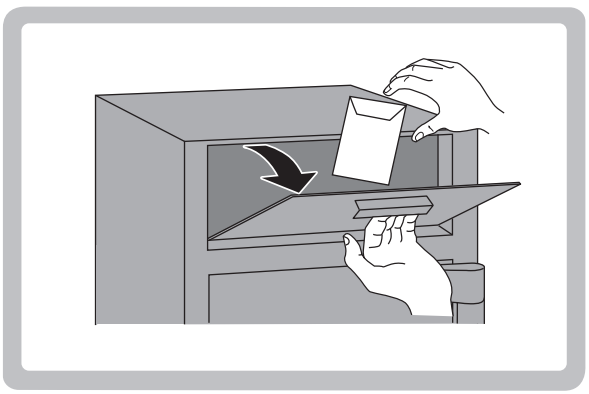
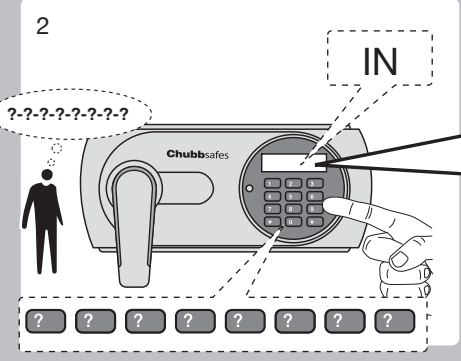
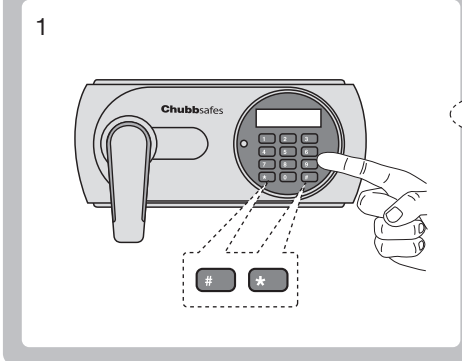
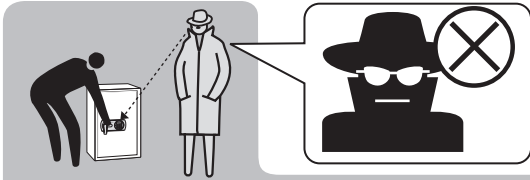

Chubbsafes
Trusted the world over.

<http://www.chubbsafes.com>

'Chubb' is owned by Chubb plc and is a registered trademark used under license